

15LBS. CO₂ PORTABLE FIRE EXTINGUISHER
MODEL-N 15L C

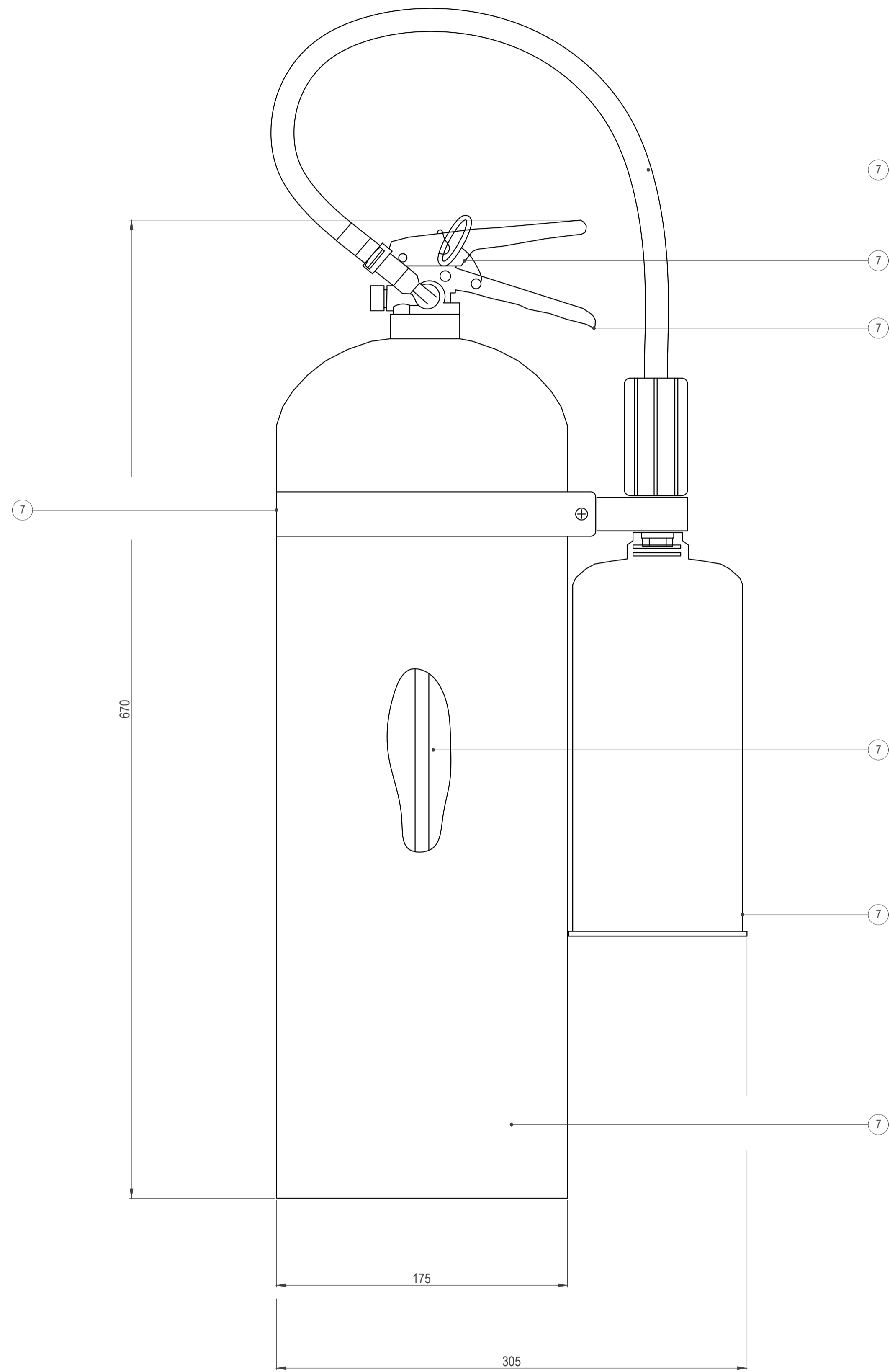

NOTES :-

1. ALL DIMENSIONS ARE IN mm. UNLESS OTHERWISE SPECIFIED

BILL OF MATERIALS

ITEM NO.	DESCRIPTION	MATERIAL	QTY.
1.	HOSE	HIGH PRESSURE HEAVY DUTY	1
2.	SAFETY BELT	PLASTIC	1
3.	SQUEEZE GRIP VALVE	BRASS NICKEL PLATED	1
4.	DRIP TUBE	ALUMINIUM	1
5.	HORN ASSY.	PLASTIC INJECTION MOLDED	1
6.	CYLINDER	ALUMINIUM	1
7.	BELT FOR HOSE ASSY.	GALVANIZED IRON	1

SPECIFICATIONS

MODEL	NC 15L C
EXTINGUISHING AGENT	CO ₂
AGENT CAPACITY	15 LBS (6.8KG)
UL RATING	10-B:C
CYLINDER MATERIAL	ALUMINIUM
UNIT HEIGHT	670mm +10/-0
UNIT DIAMETER	175MM
UNIT WIDTH	305MM
SHIP WEIGHT	17.1KG
DISCHARGE TIME	15Sec.
RANGE(FT/M)	4-8/1.2-2.4
APPROVAL	UL LISTED